



MedLED Chrome

Truly Cordless™ Headlight Technology



Denken, fühlen, modulare Beleuchtung...
unermüdliches Licht für das Leben!

Think, feel, modular illumination...
relentless light for life!

MedLED Chrome Stirnleuchten Headlights

Freiheit ohne Kompromisse

Die MedLED-Chrome-Stirnleuchte verfügt über die modernste Lichttechnologie, und erreicht so, was früher unmöglich war: eine Stirnleuchte, die jedes beliebige OP-Feld ausleuchten kann, sowohl in Bezug auf Lichtintensität als auch Spotgröße, und dabei lautlos, komfortabel und kabellos ist.

Merkmale

- Lichtintensität:
MC3 – 100.000 lux
MC6 – 200.000 lux
MC7 – 250.000 lux
- Akkulaufzeit:
MC3 – 7,75 Std.
MC6 – 6,75 Std.
MC7 – 3,50 Std.
- Akkulaufzeit: siehe oben, abhängig vom Modell; praktisch unbeschränkt dank Ladegerät mit 4 Ladeschächten
- USB-Ladedauer: 6,5 Stunden
- Ladedauer im 4-Schacht-Ladegerät: 10 Stunden; gleichzeitiges Aufladen von bis zu zwei Sets
- Justierung: volle Einstellbarkeit des Strahlwinkels, Links-Rechts-schwenkbar, größerer Spotgrößenbereich
- Spot-Qualität: scharf abgegrenzter, kreisförmiger Strahl mit homogenem Licht

Freedom without sacrifice

The MedLED Chrome headlight has incorporated the best that technology offers to accomplish the once impossible; a headlight that can light up any field in the O.R. in terms of both intensity and spot size and is silent, comfortable, and cordless.

Features

- Luminous intensity:
MC3 – 100,000 lux
MC6 – 200,000 lux
MC7 – 250,000 lux
- Battery service life:
MC3 – 7.75 hr
MC6 – 6.75 hr
MC7 – 3.50 hr
- Battery service life: see above, depends on model; infinite with 4-bay charger
- USB charging time: 6.5 hours
- 4-Bay charging time: 10 hours; charge up to two sets at a time
- Adjustability: full beam angle adjustability, left-to-right swivel, increased spot size range
- Spot quality: crisp, circular beam of homogenous light

MedLED Chrome

Freiheit ohne Kompromisse

Wenn Sie eine leistungsfähige, langlebige, komfortable Stirnleuchte ohne Kabel suchen, kann Ihnen KLS Martin ein vollständiges Sortiment an Stirnleuchten mit passendem Zubehör anbieten.

Freedom without sacrifice

If you have a need for a powerful, long lasting, comfortable headlight with no cord, KLS Martin is able to offer you a full range of headlights and accessories.



Intensität und Helligkeit Power and Brightness

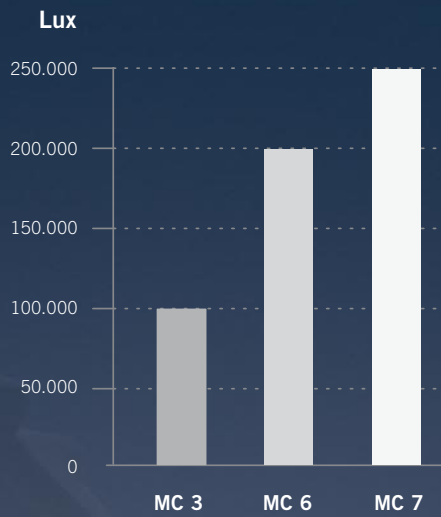

200 mm
MC 7

maximum spot diameter range
Maßstab/scale 1:1

100 mm
MC 3

90 mm
MC 6

MedLED Chrome

Integrierte Schaltkreise

Dies ist unsere Leitlinie.
Keine Gürteltasche, keine Kabel, keine Probleme,
sondern wirklich kabelloser Betrieb.
Licht ohne Kompromisse!

Keine Beeinträchtigung der Sterilität.
Ohne Kabel oder Akkupack am Gürtel.

Head-mounted circuit technology

That's our mission statement.
No cables, no hassles. Lose the optical cables
and belt pack cords and go cordless without
sacrificing basic operating light needs.

Does not interfere with sterility.
Without cables or battery belt packs,
it's kept safely above the neck.

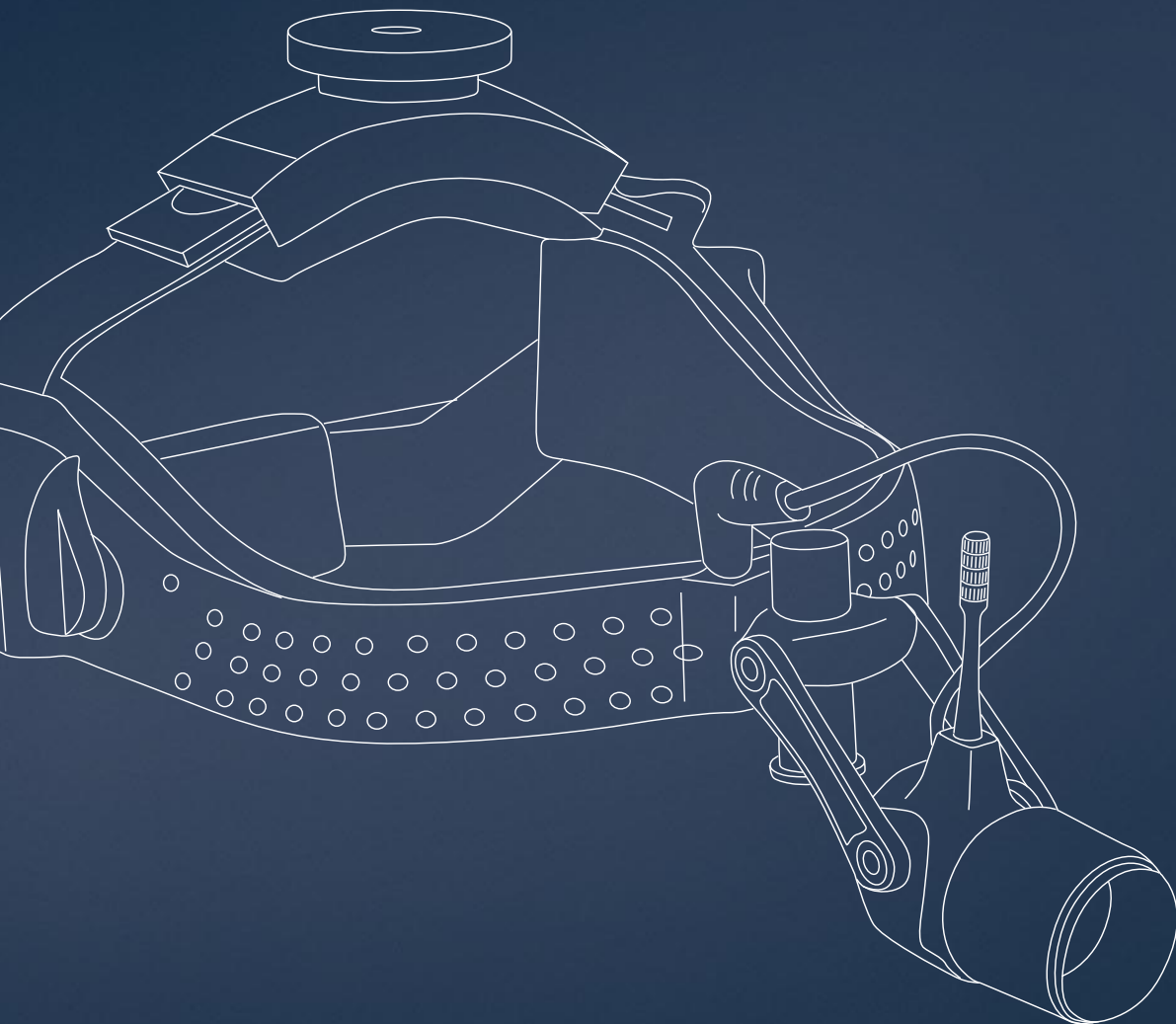

Quiet-Cool™ Kühlkörper-Technologie

Kühl und leise

Um unnötiges Erwärmen zu vermeiden, wird die LED mithilfe einer firmeneigenen Technologie sofort gekühlt. Wir haben außerdem das Gehäuse so gestaltet, dass es mögliche Restwärme selbst ableitet.

Lüfter brauchen mehr Strom und dadurch große Akkus, die an der Taille des Benutzers befestigt werden müssen. Hiermit gehören die Lüfter der Vergangenheit an.

Quiet-Cool™ Heatsink technology

Cool and quiet

Proprietary technology is used to cool the LED instantly, avoiding the potential for unnecessary heat buildup. We also designed the housing itself to manage any remaining thermal dissipation.

Fans also demand more power, requiring large batteries attached to the waist of the user.

Einstellbarkeit und Steuerung des Spots Spot Adjustability and Control

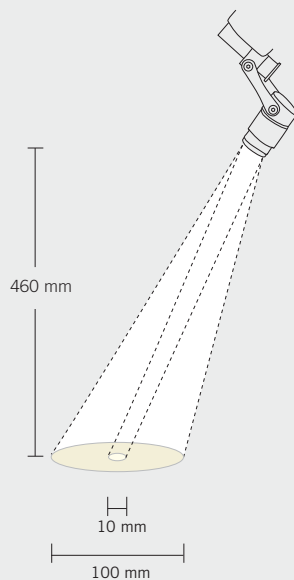

MC 3

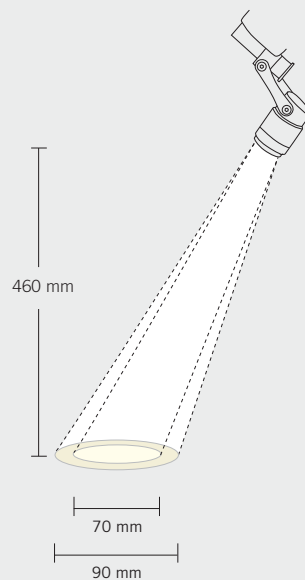

MC 6

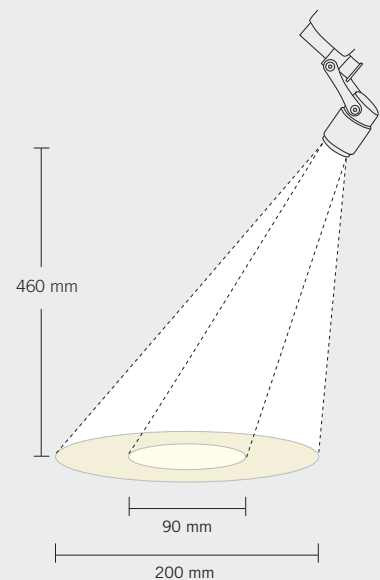

MC 7

MedLED Chrome

Stirnleuchten/Headlights

Ready to use!

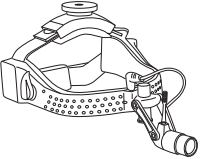
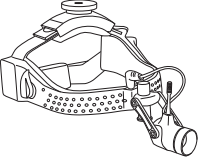
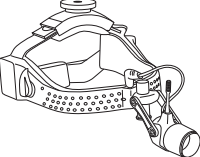
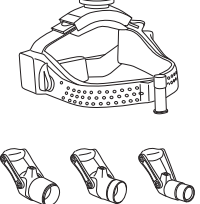
	<table border="1"> <thead> <tr> <th data-bbox="336 566 1238 600">MedLED Chrome MC 3</th> <th data-bbox="1243 566 1406 600">Item No.</th> </tr> </thead> <tbody> <tr> <td data-bbox="336 607 1238 712"> bestehend aus: Stirnleuchte MedLED Chrome MC 3 (Hardtop), Transportkoffer, USB-Ladekabel, Netzteil inkl. Adapter EU, US, UK, AU und 2 Akkus (Lithium-Polymer) </td> <td data-bbox="1243 607 1406 712"></td> </tr> <tr> <td data-bbox="336 719 1238 837"> consisting of: headlight MedLED Chrome MC 3 (hardtop), carrying case, USB charging cable, PSU incl. adapter for EU, US, UK, AU and 2 rechargeable lithium-polymer batteries </td> <td data-bbox="1243 719 1406 837">17-500-40-04</td> </tr> </tbody> </table>	MedLED Chrome MC 3	Item No.	bestehend aus: Stirnleuchte MedLED Chrome MC 3 (Hardtop), Transportkoffer, USB-Ladekabel, Netzteil inkl. Adapter EU, US, UK, AU und 2 Akkus (Lithium-Polymer)		consisting of: headlight MedLED Chrome MC 3 (hardtop), carrying case, USB charging cable, PSU incl. adapter for EU, US, UK, AU and 2 rechargeable lithium-polymer batteries	17-500-40-04
MedLED Chrome MC 3	Item No.						
bestehend aus: Stirnleuchte MedLED Chrome MC 3 (Hardtop), Transportkoffer, USB-Ladekabel, Netzteil inkl. Adapter EU, US, UK, AU und 2 Akkus (Lithium-Polymer)							
consisting of: headlight MedLED Chrome MC 3 (hardtop), carrying case, USB charging cable, PSU incl. adapter for EU, US, UK, AU and 2 rechargeable lithium-polymer batteries	17-500-40-04						
	<table border="1"> <thead> <tr> <th data-bbox="336 913 1238 947">MedLED Chrome MC 6</th> <th data-bbox="1243 913 1406 947">Item No.</th> </tr> </thead> <tbody> <tr> <td data-bbox="336 954 1238 1059"> bestehend aus: Stirnleuchte MedLED Chrome MC 6 (Hardtop), Transportkoffer, USB-Ladekabel, Netzteil inkl. Adapter EU, US, UK, AU und 2 Akkus (Lithium-Polymer) </td> <td data-bbox="1243 954 1406 1059"></td> </tr> <tr> <td data-bbox="336 1066 1238 1184"> consisting of: headlight MedLED Chrome MC 6 (hardtop), carrying case, USB charging cable, PSU incl. adapter for EU, US, UK, AU and 2 rechargeable lithium-polymer batteries </td> <td data-bbox="1243 1066 1406 1184">17-500-50-04</td> </tr> </tbody> </table>	MedLED Chrome MC 6	Item No.	bestehend aus: Stirnleuchte MedLED Chrome MC 6 (Hardtop), Transportkoffer, USB-Ladekabel, Netzteil inkl. Adapter EU, US, UK, AU und 2 Akkus (Lithium-Polymer)		consisting of: headlight MedLED Chrome MC 6 (hardtop), carrying case, USB charging cable, PSU incl. adapter for EU, US, UK, AU and 2 rechargeable lithium-polymer batteries	17-500-50-04
MedLED Chrome MC 6	Item No.						
bestehend aus: Stirnleuchte MedLED Chrome MC 6 (Hardtop), Transportkoffer, USB-Ladekabel, Netzteil inkl. Adapter EU, US, UK, AU und 2 Akkus (Lithium-Polymer)							
consisting of: headlight MedLED Chrome MC 6 (hardtop), carrying case, USB charging cable, PSU incl. adapter for EU, US, UK, AU and 2 rechargeable lithium-polymer batteries	17-500-50-04						
	<table border="1"> <thead> <tr> <th data-bbox="336 1261 1238 1294">MedLED Chrome MC 7</th> <th data-bbox="1243 1261 1406 1294">Item No.</th> </tr> </thead> <tbody> <tr> <td data-bbox="336 1301 1238 1406"> bestehend aus: Stirnleuchte MedLED Chrome MC 7 (Hardtop), Transportkoffer, USB-Ladekabel, Netzteil inkl. Adapter EU, US, UK, AU und 2 Akkus (Lithium-Polymer) </td> <td data-bbox="1243 1301 1406 1406"></td> </tr> <tr> <td data-bbox="336 1413 1238 1532"> consisting of: headlight MedLED Chrome MC 7 (hardtop), carrying case, USB charging cable, PSU incl. adapter for EU, US, UK, AU and 2 rechargeable lithium-polymer batteries </td> <td data-bbox="1243 1413 1406 1532">17-500-60-04</td> </tr> </tbody> </table>	MedLED Chrome MC 7	Item No.	bestehend aus: Stirnleuchte MedLED Chrome MC 7 (Hardtop), Transportkoffer, USB-Ladekabel, Netzteil inkl. Adapter EU, US, UK, AU und 2 Akkus (Lithium-Polymer)		consisting of: headlight MedLED Chrome MC 7 (hardtop), carrying case, USB charging cable, PSU incl. adapter for EU, US, UK, AU and 2 rechargeable lithium-polymer batteries	17-500-60-04
MedLED Chrome MC 7	Item No.						
bestehend aus: Stirnleuchte MedLED Chrome MC 7 (Hardtop), Transportkoffer, USB-Ladekabel, Netzteil inkl. Adapter EU, US, UK, AU und 2 Akkus (Lithium-Polymer)							
consisting of: headlight MedLED Chrome MC 7 (hardtop), carrying case, USB charging cable, PSU incl. adapter for EU, US, UK, AU and 2 rechargeable lithium-polymer batteries	17-500-60-04						
	<table border="1"> <thead> <tr> <th data-bbox="336 1608 1238 1641">MedLED Chrome MC 3/6/7</th> <th data-bbox="1243 1608 1406 1641">Item No.</th> </tr> </thead> <tbody> <tr> <td data-bbox="336 1648 1238 1753"> bestehend aus: Stirnleuchte MedLED Chrome MC 3, MC 6, MC 7 (Hardtop), Transportkoffer, USB-Ladekabel, Netzteil inkl. Adapter EU, US, UK, AU und 2 Akkus (Lithium-Polymer) </td> <td data-bbox="1243 1648 1406 1753"></td> </tr> <tr> <td data-bbox="336 1760 1238 1879"> consisting of: headlight MedLED Chrome MC 3, MC 6, MC 7 (hardtop), carrying case, USB charging cable, PSU incl. adapter for EU, US, UK, AU and 2 rechargeable lithium-polymer batteries </td> <td data-bbox="1243 1760 1406 1879">17-500-70-04</td> </tr> </tbody> </table>	MedLED Chrome MC 3/6/7	Item No.	bestehend aus: Stirnleuchte MedLED Chrome MC 3, MC 6, MC 7 (Hardtop), Transportkoffer, USB-Ladekabel, Netzteil inkl. Adapter EU, US, UK, AU und 2 Akkus (Lithium-Polymer)		consisting of: headlight MedLED Chrome MC 3, MC 6, MC 7 (hardtop), carrying case, USB charging cable, PSU incl. adapter for EU, US, UK, AU and 2 rechargeable lithium-polymer batteries	17-500-70-04
MedLED Chrome MC 3/6/7	Item No.						
bestehend aus: Stirnleuchte MedLED Chrome MC 3, MC 6, MC 7 (Hardtop), Transportkoffer, USB-Ladekabel, Netzteil inkl. Adapter EU, US, UK, AU und 2 Akkus (Lithium-Polymer)							
consisting of: headlight MedLED Chrome MC 3, MC 6, MC 7 (hardtop), carrying case, USB charging cable, PSU incl. adapter for EU, US, UK, AU and 2 rechargeable lithium-polymer batteries	17-500-70-04						

MedLED Chrome

Zubehör/Accessories

Vergößerungslinsen MC 3 Magnifier lenses MC 3

Vergößerung Magnification	Dioptrin	Vergößerung	Erhöhung der Sehkraft	Optische Leistung	Empfohlener Arbeits- abstand (Brennweite) Recommended working distance (focal length)	Art.-Nr. Item No.
	Diopter	Magnification	Increase in eyesight	Optical power		
	+ 2	+ 0.40	40 %	1.4 x	250 mm	17-500-12-04
	+ 3	+ 0.60	60 %	1.6 x	220 mm	17-500-13-04
	+ 4	+ 0.80	80 %	1.8 x	200 mm	17-500-14-04

Vergößerungslinsen MC 6 / MC 7 Magnifier lenses MC 6 / MC 7

Vergößerung Magnification	Dioptrin	Vergößerung	Erhöhung der Sehkraft	Optische Leistung	Empfohlener Arbeits- abstand (Brennweite) Recommended working distance (focal length)	Art.-Nr. Item No.
	Diopter	Magnification	Increase in eyesight	Optical power		
	+ 2	+ 0.40	40 %	1.4 x	250 mm	17-500-22-04
	+ 3	+ 0.60	60 %	1.6 x	220 mm	17-500-23-04
	+ 4	+ 0.80	80 %	1.8 x	200 mm	17-500-24-04

Ladegerät Desktop charger

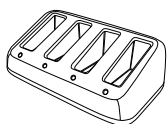

17-500-17-04

Ersatzakkus (2 St.) Spare batteries, rechargeable (2 pcs.)

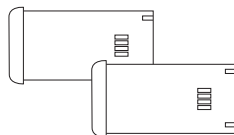

17-500-21-04

Koffer Carrying case

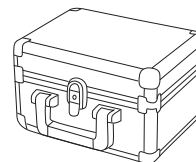

17-500-29-04

MedLED Chrome Zubehör/Accessories

Ersatzstirnbänder Spare head bands

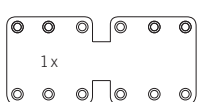

17-500-25-04
Neoprene Snap-Around
für/for Hardtop

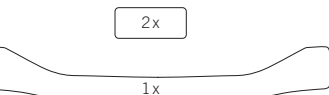
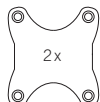

17-500-26-04
Neoprene Velcro
für/for Hardtop

17-500-27-04
Soft Pillow Velcro
für/for Hardtop

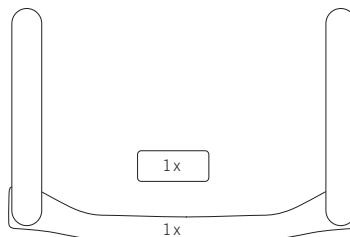

17-500-28-04
Soft Pillow Velcro
für/for Softtop

GoPro Adapter

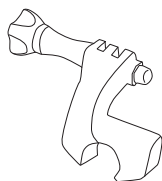

17-500-31-04

Ersatzkopfband Spare headstrap

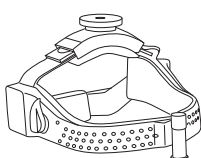

17-500-32-04
Hardtop

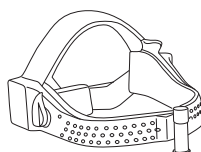

17-500-33-04
Softtop

Gelbfilter (für Dental) Amber filter (for Dental)



17-500-34-04
MC 3



17-500-35-04
MC 6

Leuchtkörper Bezel

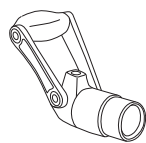

17-500-41-04
MC 3

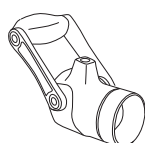

17-500-51-04
MC 6

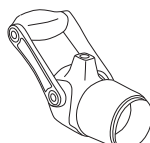

17-500-61-04
MC 7

Ladegerät/Netzstecker Desktop charger/Mains plug

		Art.-Nr. / Item No.	
		EU	17-500-01-04
		US	17-500-02-04
		UK	17-500-03-04
		AU	17-500-04-04

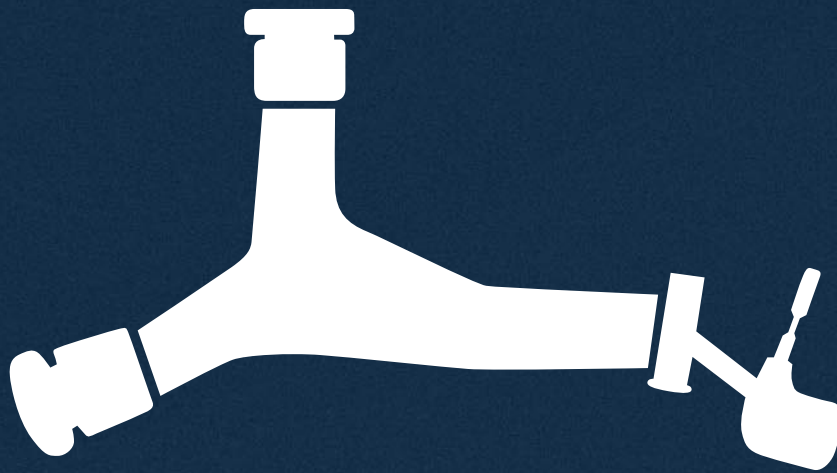

truly cordless™

KLS Martin Group

KLS Martin Australia Pty Ltd.

Sydney · Australia
Tel. +61 2 9439 5316
australia@klsmartin.com

KLS Martin India Pvt Ltd.

Chennai · India
Tel. +91 44 66 442 300
india@klsmartin.com

Martin Nederland/Marned B.V.

Huizen · The Netherlands
Tel. +31 35 523 45 38
nederland@klsmartin.com

KLS Martin LP

Jacksonville · Florida, USA
Tel. +1 904 641 77 46
usa@klsmartin.com

KLS Martin do Brasil Ltda.

São Paulo · Brazil
Tel. +55 11 3554 2299
brazil@klsmartin.com

Martin Italia S.r.l.

Milan · Italy
Tel. +39 039 605 67 31
italia@klsmartin.com

Gebrüder Martin GmbH & Co. KG

Moscow · Russia
Tel. +7 499 792-76-19
russia@klsmartin.com

Gebrüder Martin GmbH & Co. KG

Shanghai · China
Tel. +86 21 5820 6251
china@klsmartin.com

Nippon Martin K.K.

Tokyo · Japan
Tel. +81 3 3814 1431
nippon@klsmartin.com

Gebrüder Martin GmbH & Co. KG

Dubai · United Arab Emirates
Tel. +971 4 454 16 55
middleeast@klsmartin.com

KLS Martin France SARL

Mulhouse · France
Tel. +33 3 8951 3150
france@klsmartin.com

KLS Martin SE Asia Sdn. Bhd.

Penang · Malaysia
Tel. +604 505 7838
malaysia@klsmartin.com

KLS Martin UK Ltd.

London · United Kingdom
Tel. +44 1189 000 570
uk@klsmartin.com

Gebrüder Martin GmbH & Co. KG

A company of the KLS Martin Group

KLS Martin Platz 1 · 78532 Tuttlingen · Germany
P.O. Box 60 · 78501 Tuttlingen · Germany
Tel. +49 7461 706-0 · Fax +49 7461 706-193
info@klsmartin.com · www.klsmartin.com

