

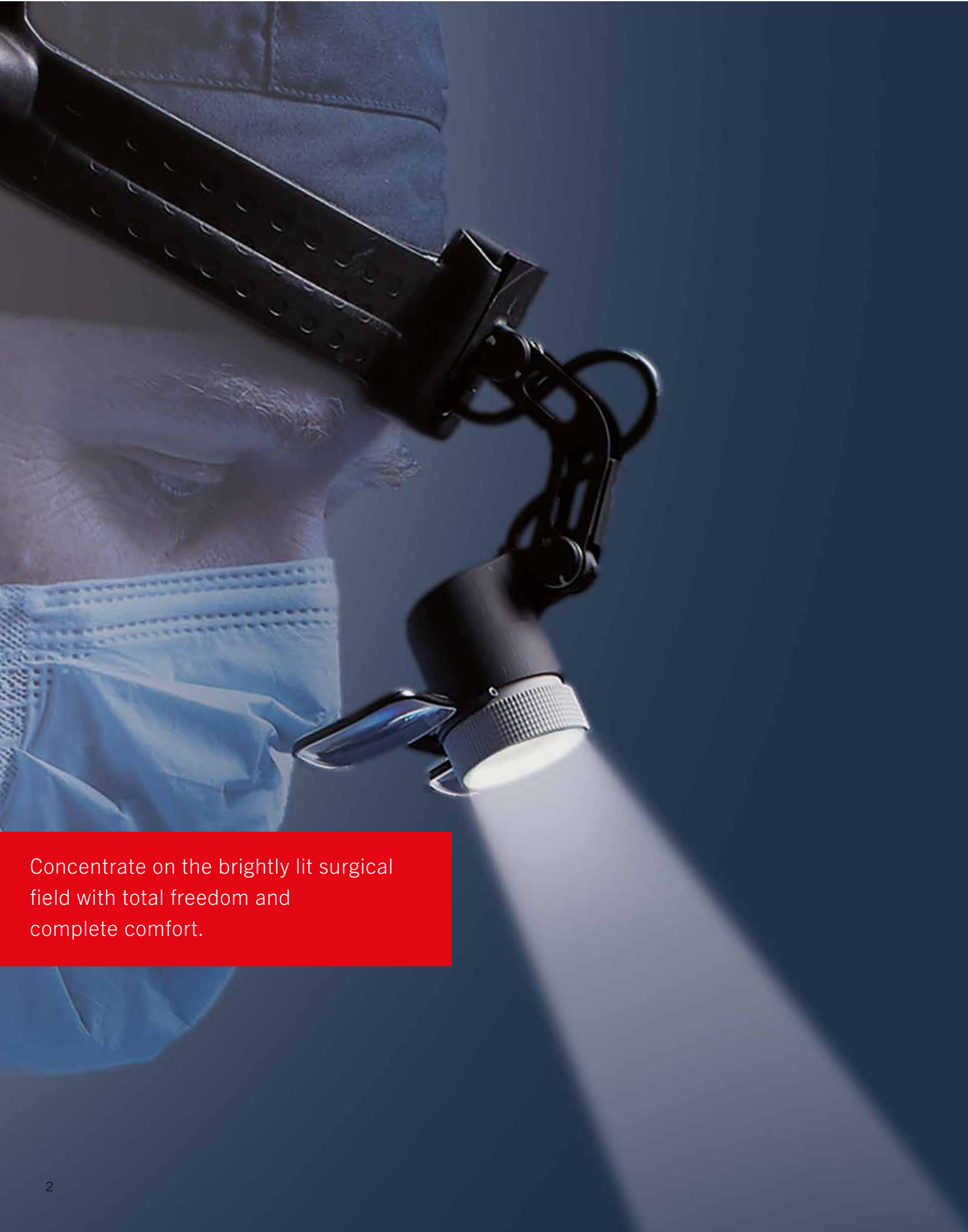

MedLED[®] Spectra
Cordless Surgical Headlight



Concentrate on the brightly lit surgical field with total freedom and complete comfort.

MedLED® Spectra

Cordless Surgical Headlight

Freedom without sacrifice

The MedLED® Spectra headlight has incorporated the best technology to accomplish the once impossible: a silent, comfortable, cordless headlight that is versatile across many specialties in the clinic or operating room and will enhance your surgical experience in terms of both intensity and spot size.

Features luminous intensity:

- G3 - 100,000 lux
- G6 - 200,000 lux
- G8 - 300,000 lux – now even brighter

Battery service life (infinite with 4-bay charger):

- G3 - 10 hours
- G6 - 8 hours
- G8 - 5 hours

Lightweight:

Headlight weighs 260 g

USB charging time:

4 hours (2 batteries)

4-Bay charging time:

2 hours (4 batteries); charge up to two sets at a time

Adjustability:

Full beam angle adjustability and increased spot size range

Spot quality:

Crisp, circular beam of homogenous light

Convertible:

Interchangeable headband for hard or soft top

Freedom without sacrifice

If you have a need for a powerful, long lasting, comfortable headlight with no cord, KLS Martin is able to offer you a full range of headlights and accessories.

200 mm
G8

100 mm
G3

90 mm
G6

maximum spot diameter range
Scale 1:1

Unparalleled brightness

MedLED® Spectra is the light that tailors to you with two headbands and three light options. Choose a light that can power a beam bright enough to see all you need in clinical and OR settings.

Power and brightness

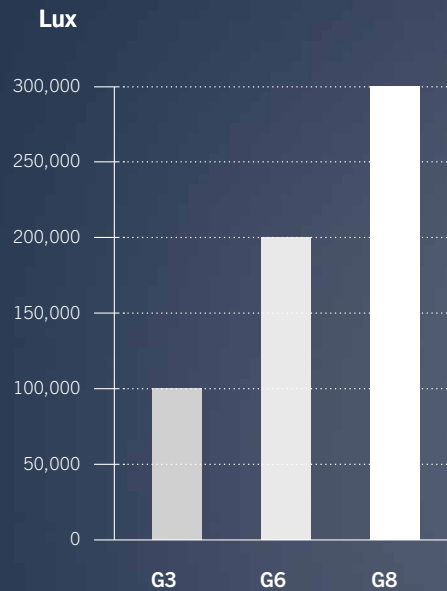

Quiet-Cool™ Heatsink technology

Cool and quiet
Proprietary technology is used to cool the LED instantly, avoiding the potential for unnecessary heat buildup. We also designed the housing itself to manage any remaining thermal dissipation.

Fans also demand more power, requiring large batteries attached to the waist of the user. This makes fans a thing of the past.



G3

G6

G8

Spot adjustability and control

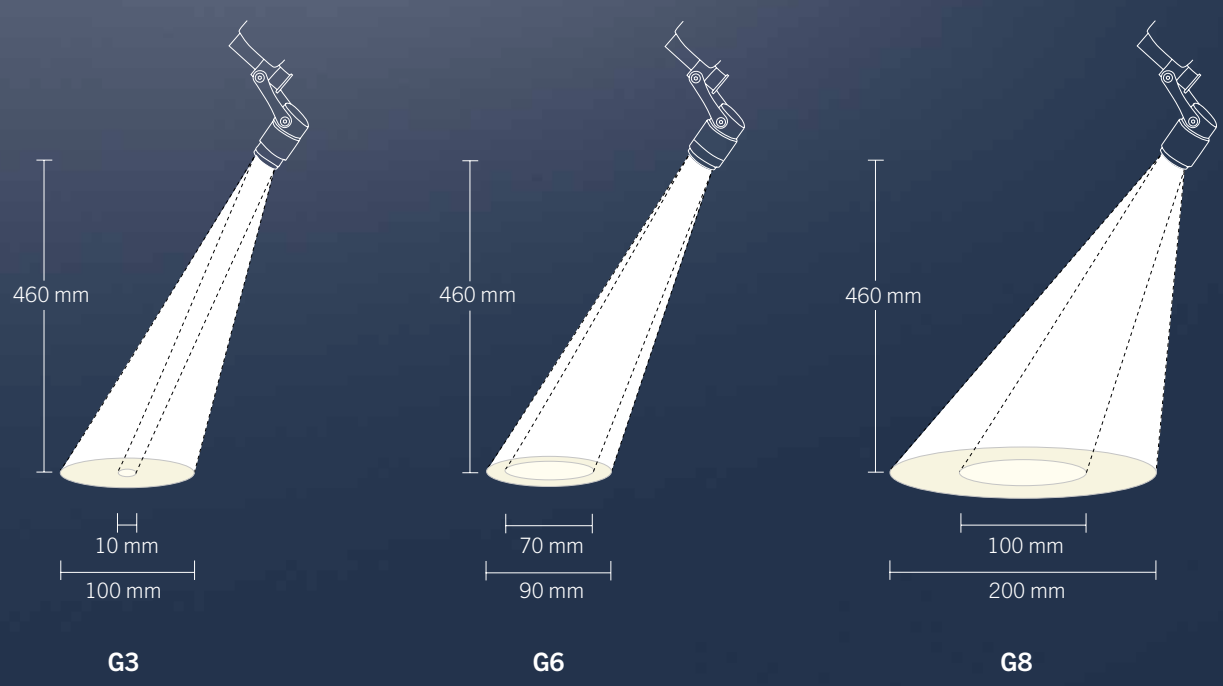

Convertible Top

Kit comes convertible with both hard top and soft top to choose from for optimal comfort.

Hard top



Soft top



Snap on and off for convenient top conversion



Go Cordless

Untether from cords and heavy belt battery packs. Dual Everlast™ batteries are integrated into the patented headband and can be changed without losing power.

Battery life

Hours

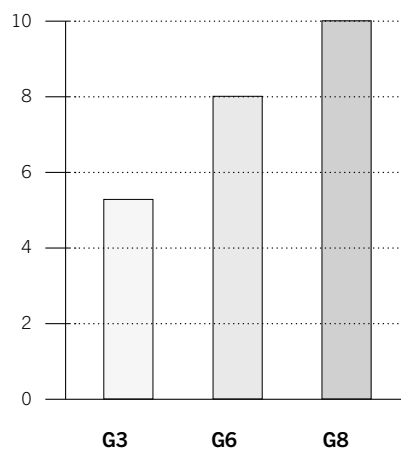

Extra power

The latest in lithium battery technology



4-bay desktop charger

Charge through backup station





Rapid USB-C charger

Charge through headband



MedLED® Spectra
Headlights
Ready to use!



	<p>MedLED® Spectra G3</p> <p>Consisting of:</p> <ul style="list-style-type: none"> ■ Spectra G3 headlight ■ Carrying case ■ Universal power plug ■ Padding conversion kit ■ 2 rechargeable lithium-polymer batteries 	<p>Item No.</p> <p>17-510-30-04 Spectra G3 standard kit*</p> <p>17-510-31-04 Spectra G3 hospital kit*</p>
	<p>MedLED® Spectra G6</p> <p>Consisting of:</p> <ul style="list-style-type: none"> ■ Spectra G6 headlight ■ Carrying case ■ Universal power plug ■ Padding conversion kit ■ 2 rechargeable lithium-polymer batteries 	<p>Item No.</p> <p>17-510-60-04 Spectra G6 standard kit*</p> <p>17-510-61-04 Spectra G6 hospital kit*</p>
	<p>MedLED® Spectra G8</p> <p>Consisting of:</p> <ul style="list-style-type: none"> ■ Spectra G8 headlight ■ Carrying case ■ Universal power plug ■ Padding conversion kit ■ 2 rechargeable lithium-polymer batteries 	<p>Item No.</p> <p>17-510-80-04 Spectra G8 standard kit*</p> <p>17-510-81-04 Spectra G8 hospital kit*</p>

*Hospital Kit (HK) comes with 4 extra batteries and a 4-bay desktop charger (Item No. 17-510-13-04) for backup battery power in a high usage environment.

MedLED® Spectra
Accessories



Magnifier lenses G3

	Diopter	Magnification	Increase in eyesight	Optical power	Recommended working distance (focal length)	Item No.
	+ 2	+ 0.40	40%	1.4 x	250 mm	17-500-12-04
	+ 3	+ 0.60	60%	1.6 x	220 mm	17-500-13-04
	+4	+ 0.80	80%	1.8 x	200 mm	17-500-14-04

Magnifier lenses G6 / G8

	Diopter	Magnification	Increase in eyesight	Optical power	Recommended working distance (focal length)	Item No.
	+ 2	+ 0.40	40%	1.4 x	250 mm	17-500-22-04
	+ 3	+ 0.60	60%	1.6 x	220 mm	17-500-23-04
	+4	+ 0.80	80%	1.8 x	200 mm	17-500-24-04

MedLED® Spectra Accessories



17-510-13-04
4-bay desktop charger



17-510-10-04
Spare batteries,
rechargeable (2 pcs.)



17-510-11-04
USB-C power plug



17-510-06-04
Spare padding set



17-510-15-04
Camera adapter



17-500-29-04
Carrying case, hard

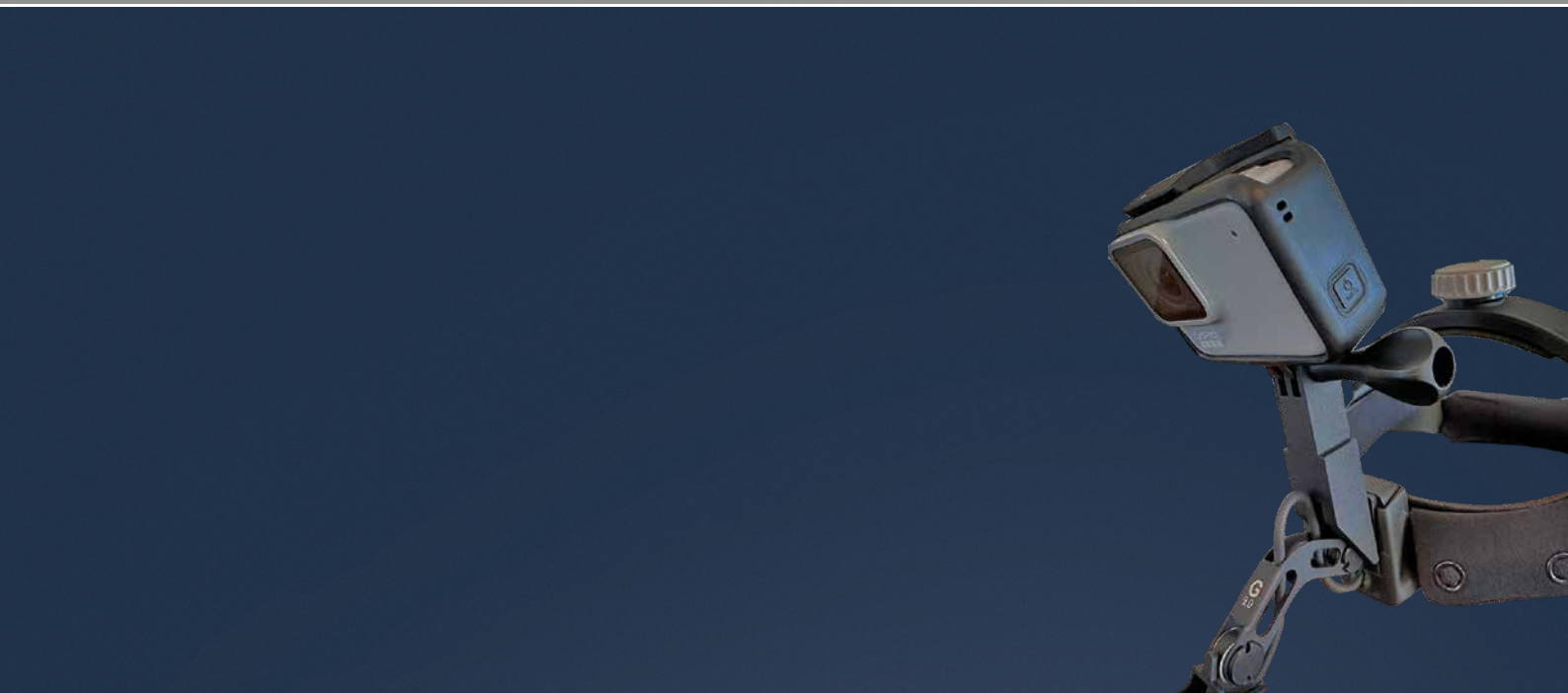

Bezel



17-510-32-04
G3



17-510-62-04
G6



17-510-82-04
G8

Amber filter (for dental)



17-500-34-04
G3



17-500-35-04
G6

17-510-08-04
Spare head unit

17-510-07-04
Headband set (HT and ST)



17-510-14-04
4-bay wall charge station

KLS Martin Group

KLS Martin Australia Pty Ltd.

Sydney · Australia
Tel. +61 2 9439 5316
australia@klsmartin.com

Martin Italia S.r.l.

Milan · Italy
Tel. +39 039 605 67 31
italia@klsmartin.com

Martin Nederland/Marned B.V.

Huizen · Netherlands
Tel. +31 35 523 45 38
infonl@klsmartin.com

KLS Martin UK Ltd.

Reading · United Kingdom
Tel. +44 118 467 1500
uk@klsmartin.com

KLS Martin do Brasil Ltda.

São Paulo · Brazil
Tel. +55 11 3554 2299
brazil@klsmartin.com

Nippon Martin K.K.

Tokyo · Japan
Tel. +81 3 3814 1431
nippon@klsmartin.com

Gebrüder Martin GmbH & Co. KG

Moscow · Russia
Tel. +7 499 792 76 19
russia@klsmartin.com

KLS Martin LP

Jacksonville · Florida, USA
Tel. +1 904 641 77 46
usa@klsmartin.com

KLS Martin Medical (Shanghai) International Trading Co., Ltd

Shanghai · China
Tel. +86 21 5820 6251
china@klsmartin.com

KLS Martin SE Asia Sdn. Bhd.

Penang · Malaysia
Tel. +604 506 2380
malaysia@klsmartin.com

KLS Martin Taiwan Ltd.

Taipei 106 · Taiwan
Tel. +886 2 2325 3169
taiwan@klsmartin.com

KLS Martin India Pvt Ltd.

Chennai · India
Tel. +91 44 66 442 300
india@klsmartin.com

KLS Martin de México S.A. de C.V.

Mexico City · Mexico
Tel. +52 55 7572 0944
mexico@klsmartin.com

Gebrüder Martin GmbH & Co. KG

Dubai · United Arab Emirates
Tel. +971 4 454 16 55
middleeast@klsmartin.com

Gebrüder Martin GmbH & Co. KG

A company of the KLS Martin Group

KLS Martin Platz 1 · 78532 Tuttlingen · Germany
P.O. Box 60 · 78501 Tuttlingen · Germany
Tel. +49 7461 706-0 · Fax +49 7461 706-193
info@klsmartin.com · www.klsmartin.com